

CAPA DOBRADIÇA 40MM

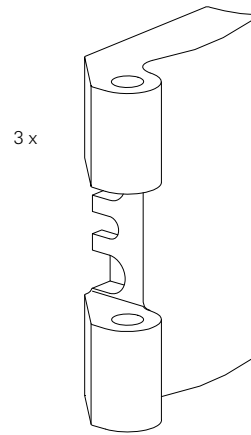

Fora de escala

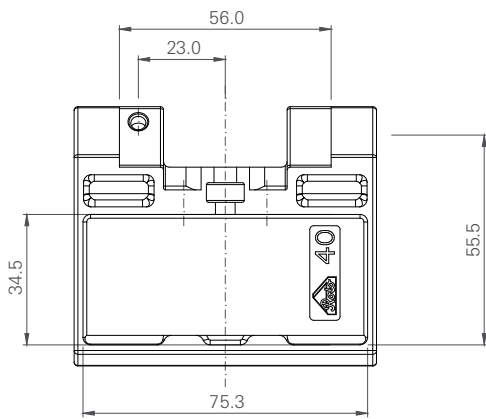

1:2

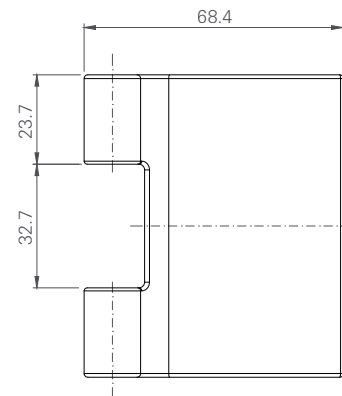

1:2

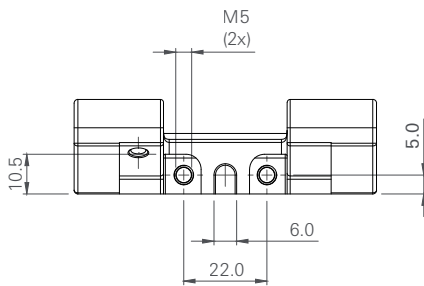

1:2

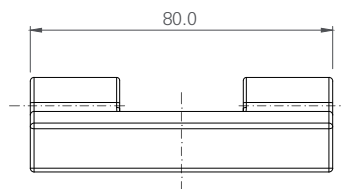



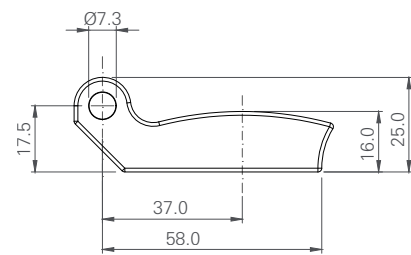

1:2



1:2

CARACTERÍSTICAS

Informação do produto	 RAL	 Logo	 Info.	 Pcte.	 Código
Branco	9016	Sim	-	1	733366
Preto	9005	Sim	-	1	768757
Prata	-	Sim	-	1	733368

COMPOSIÇÃO

Alumínio.

EMBALAGEM

3 Capas de dobradiça.

OBSERVAÇÕES

- Permite ajuste na folga da folha;
- Os parafusos são fornecidos na conjuntos placa de fixação;